

| A | B | C1 | C2 | C3 | D |
|---|-----------|------|-----|-----|-----|
| 1 | M244-4301 | 500 | 850 | 19 | 1/1 |
| 2 | M244-5563 | 1010 | 80 | 22, | 1/1 |
| 3 | M244-5566 | 480 | 80 | 22, | 1/1 |

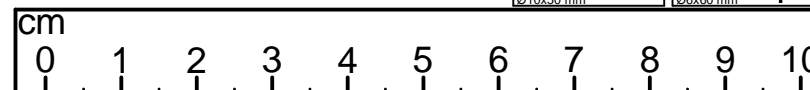

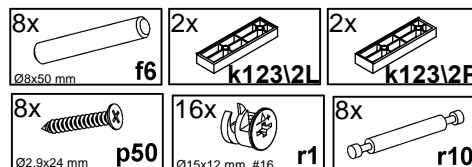
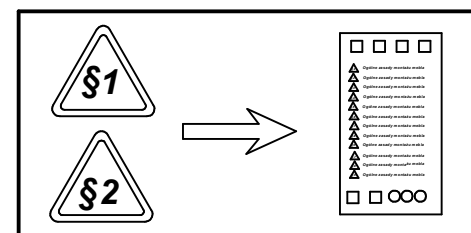
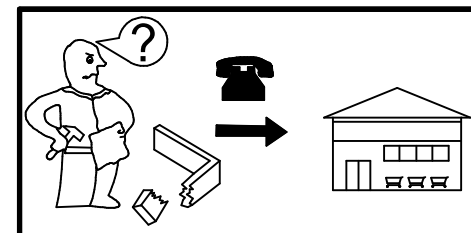
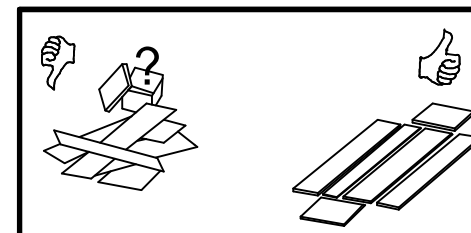
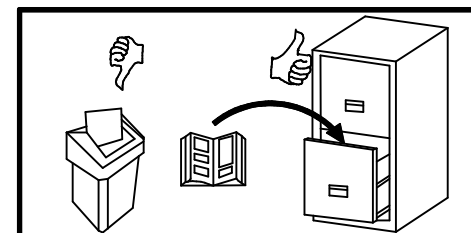
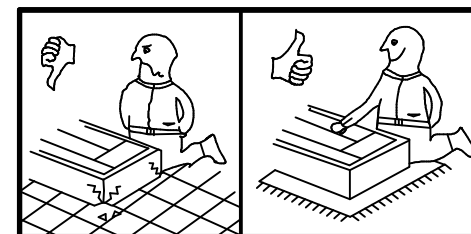
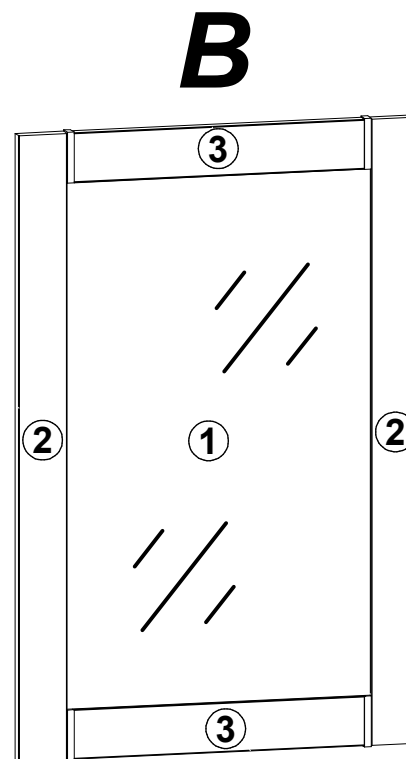
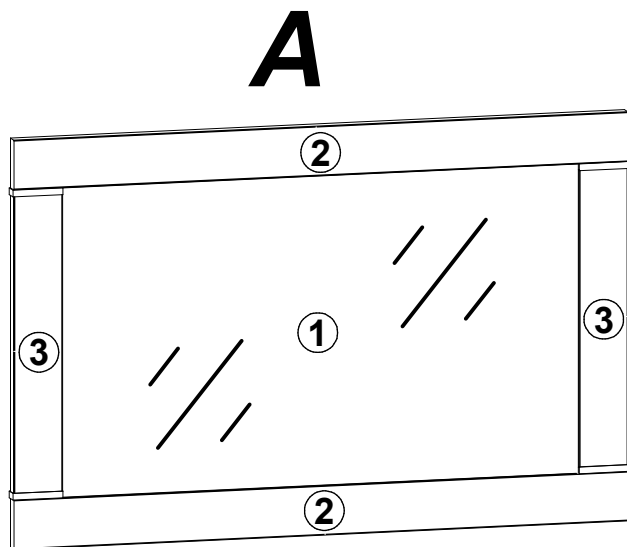
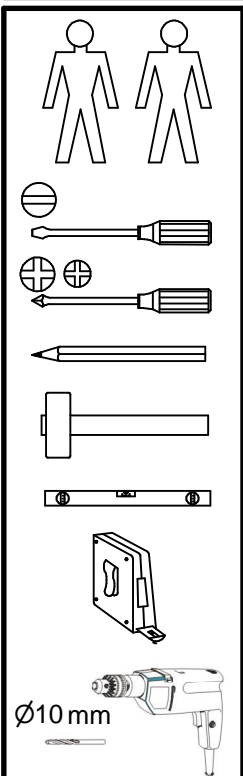
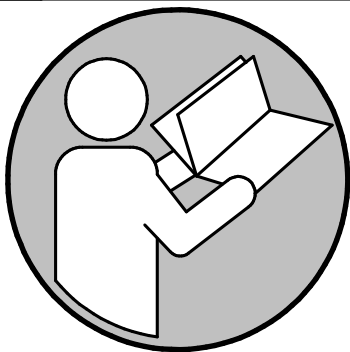
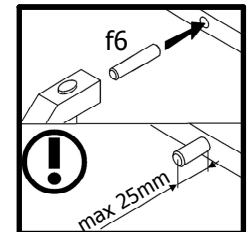
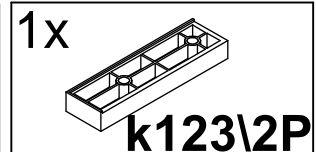
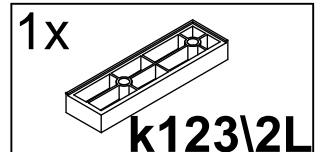
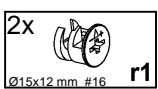
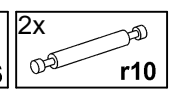
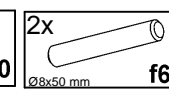
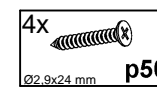
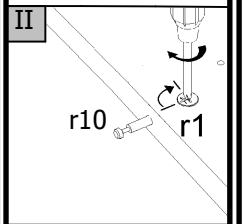
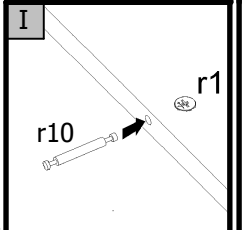
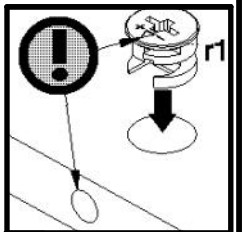
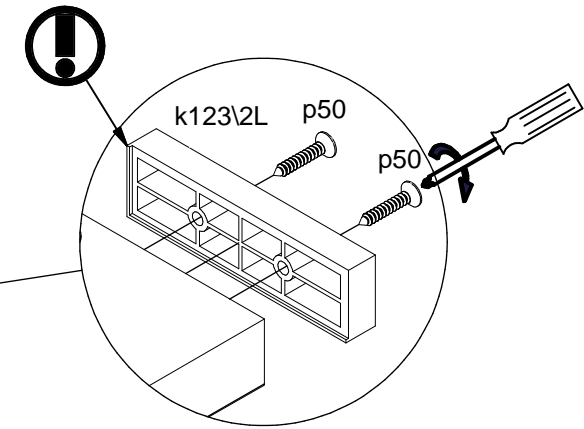
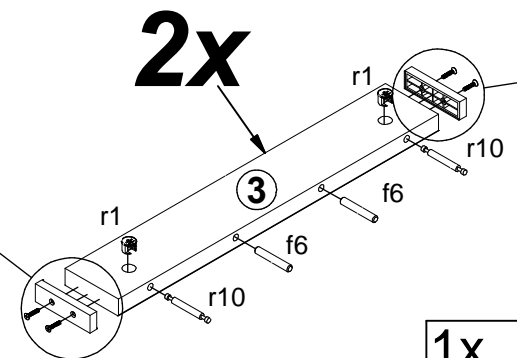
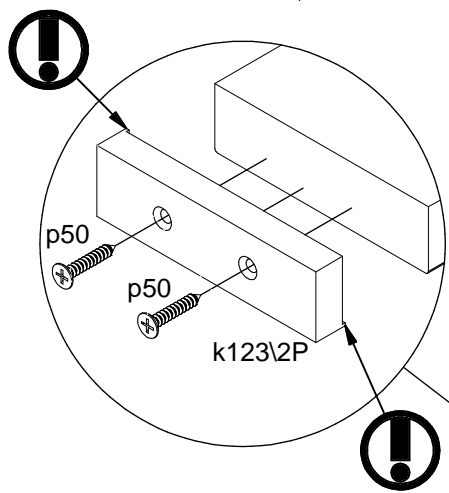
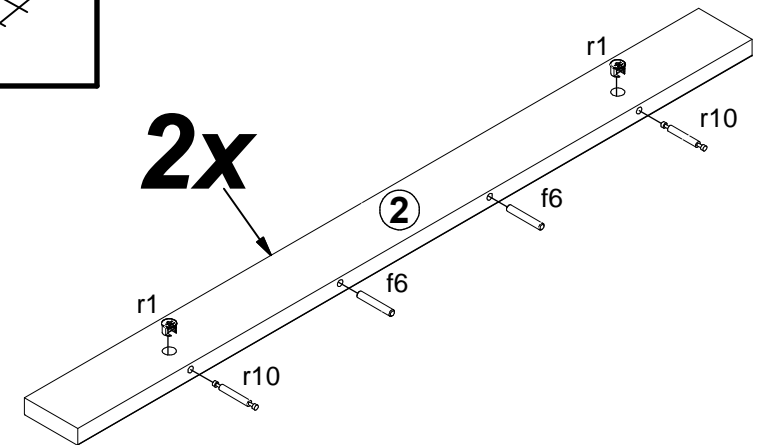
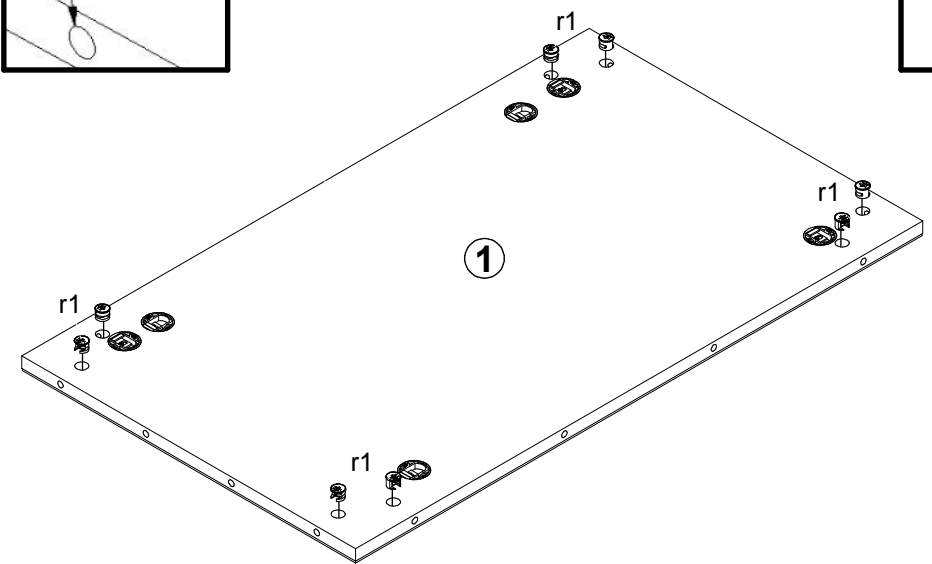
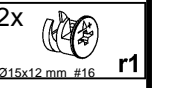
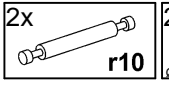
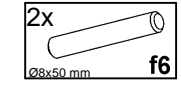
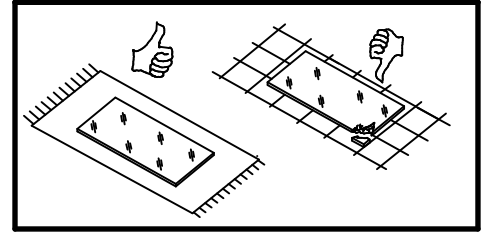
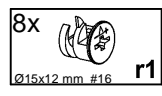
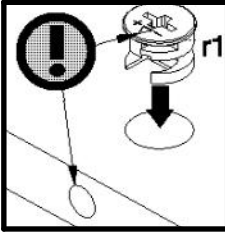

A

M244-LUS/7/10

3 / 4

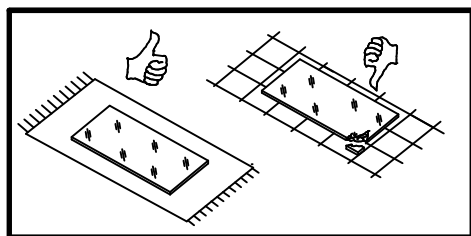
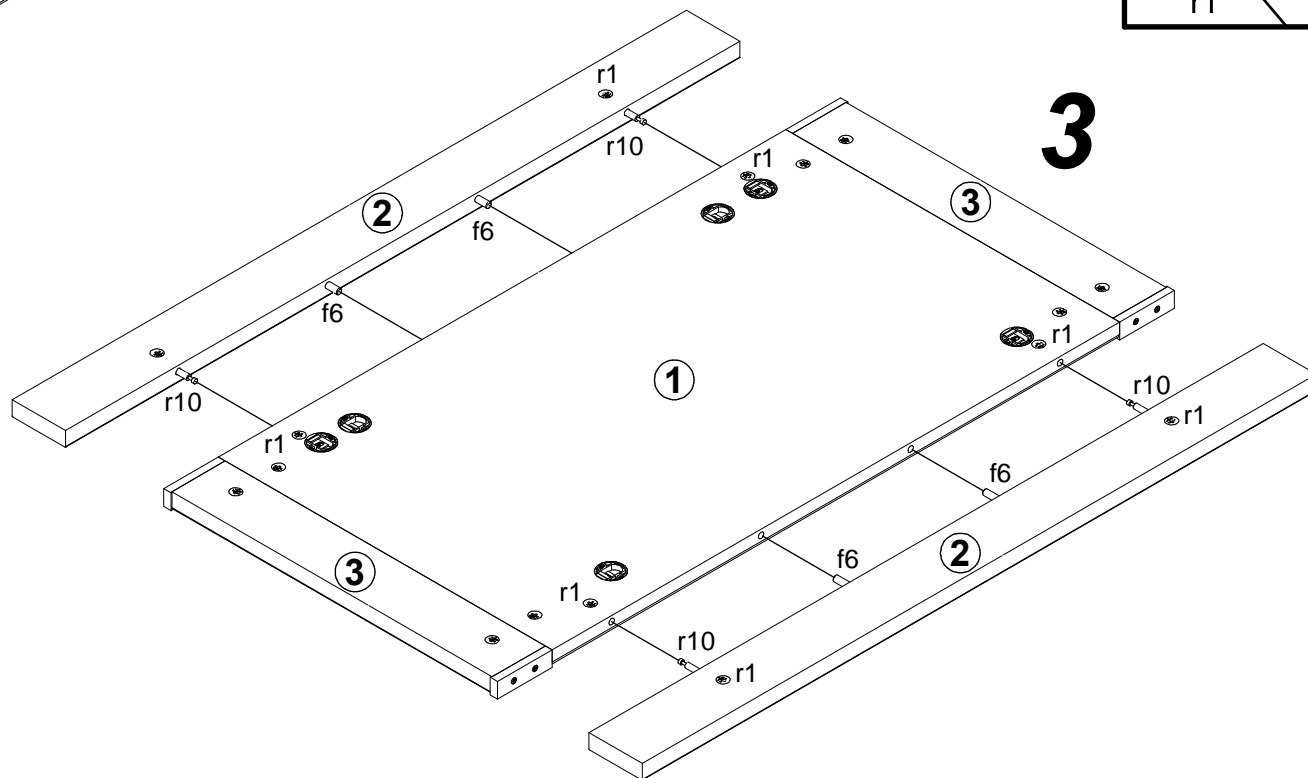
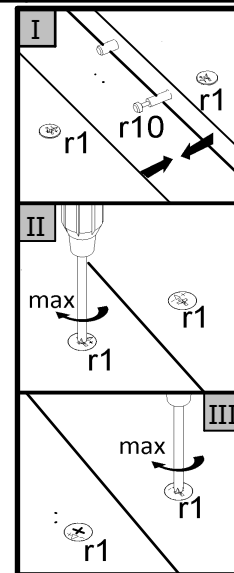
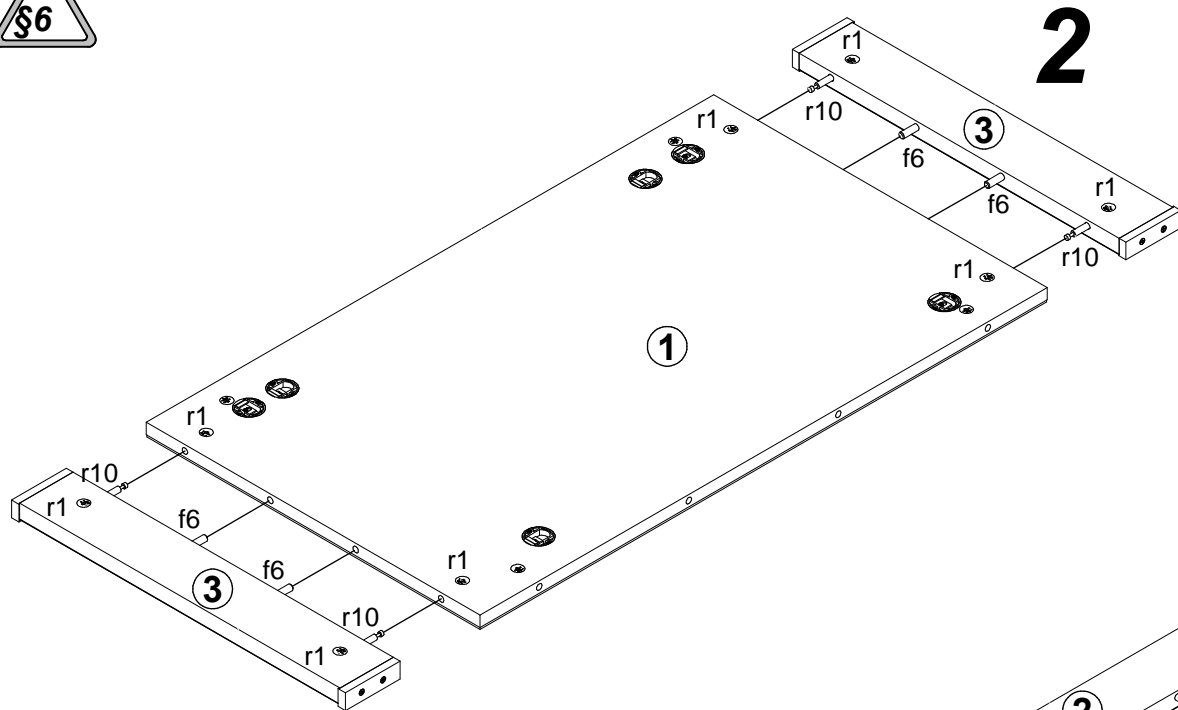

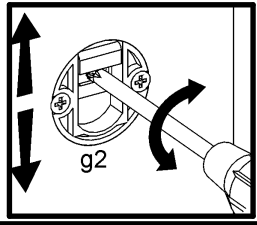
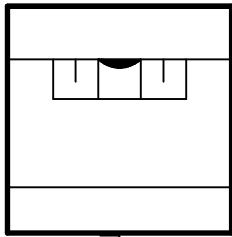

φ10 mm

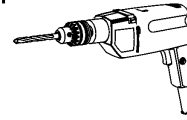

f35

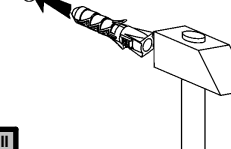

f35

p75

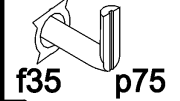

f35 p75

A

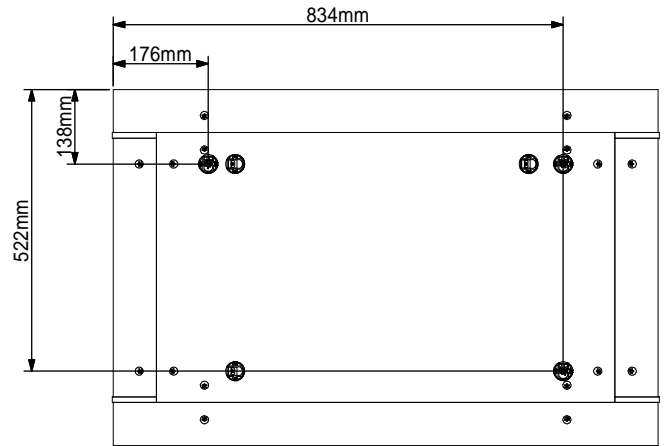
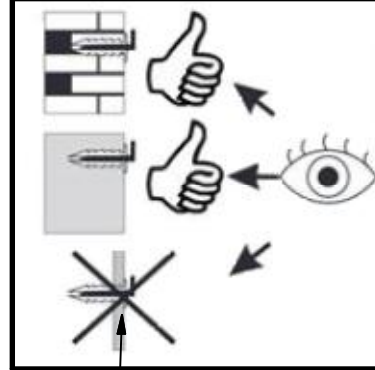
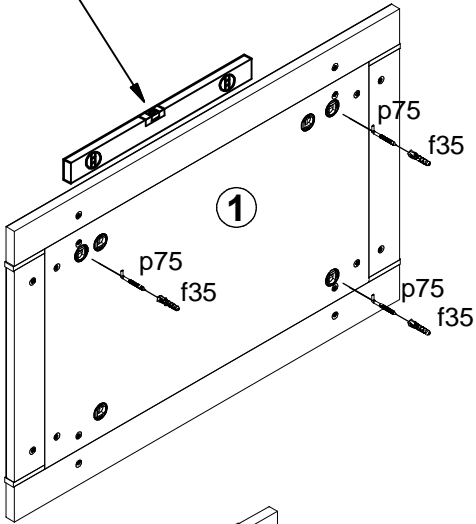

A

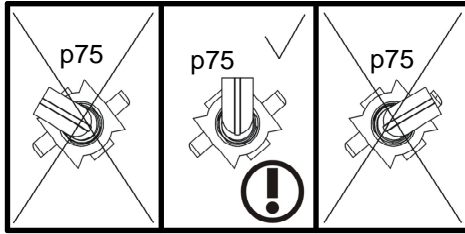
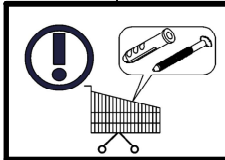

B

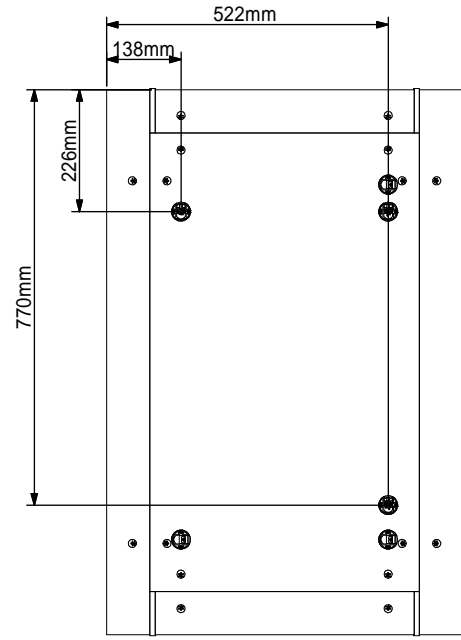
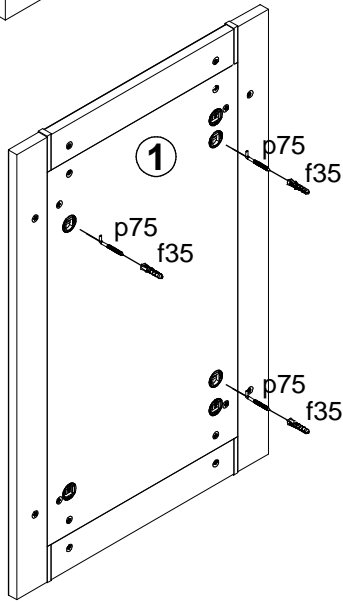

B

